

100mA, Low Noise, LDO Micropower Regulators in TSOT-23

FEATURES

- **Low Noise:** $20\mu\text{V}_{\text{RMS}}$ (10Hz to 100kHz)
- **Low Quiescent Current:** 20 μA
- **Wide Input Voltage Range:** 1.8V to 20V
- **Output Current:** 100mA
- **Very Low Shutdown Current:** <0.1 μA
- **Low Dropout Voltage:** 300mV at 100mA
- Fixed Output Voltages: 1.2V, 1.5V, 1.8V, 2V, 2.5V, 2.8V, 3V, 3.3V, 5V
- Adjustable Output from 1.22V to 20V
- Stable with 1 μF Output Capacitor
- Stable with Aluminum, Tantalum or Ceramic Capacitors
- Reverse-Battery Protected
- No Reverse Current
- No Protection Diodes Needed
- Overcurrent and Overtemperature Protected
- Available in Tiny 5-Lead TSOT-23 Package

APPLICATIONS

- Cellular Phones
- Pagers
- Battery-Powered Systems
- Frequency Synthesizers
- Wireless Modems

DESCRIPTION

The LT[®]1761 series are micropower, low noise, low dropout regulators. With an external 0.01 μF bypass capacitor, output noise drops to $20\mu\text{V}_{\text{RMS}}$ over a 10Hz to 100kHz bandwidth. Designed for use in battery-powered systems, the low 20 μA quiescent current makes them an ideal choice. In shutdown, quiescent current drops to less than 0.1 μA . The devices are capable of operating over an input voltage from 1.8V to 20V, and can supply 100mA of output current with a dropout voltage of 300mV. Quiescent current is well controlled, not rising in dropout as it does with many other regulators.

The LT1761 regulators are stable with output capacitors as low as 1 μF . Small ceramic capacitors can be used without the series resistance required by other regulators.

Internal protection circuitry includes reverse battery protection, current limiting, thermal limiting and reverse current protection. The device is available in fixed output voltages of 1.2V, 1.5V, 1.8V, 2V, 2.5V, 2.8V, 3V, 3.3V and 5V, and as an adjustable device with a 1.22V reference voltage. The LT1761 regulators are available in the 5-lead TSOT-23 package.

LT, LT, LTC, LTM, Linear Technology, the Linear logo and Burst Mode are registered trademarks of Linear Technology Corporation. All other trademarks are the property of their respective owners.

TYPICAL APPLICATION

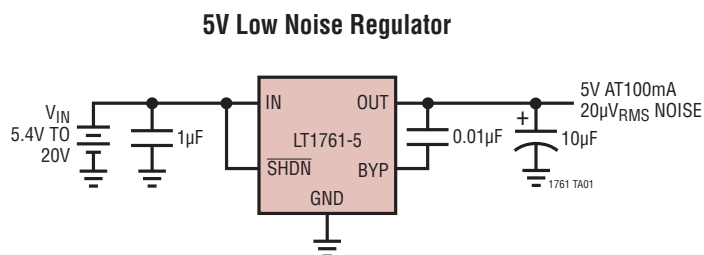

10Hz to 100kHz Output Noise

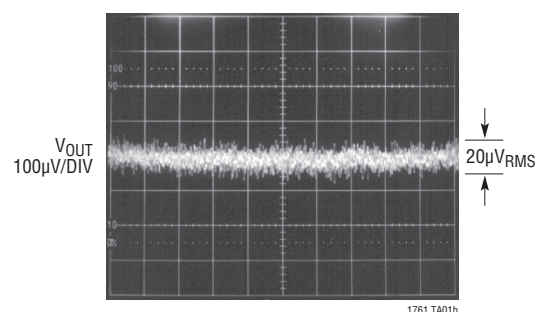

ABSOLUTE MAXIMUM RATINGS (Note 1)

IN Pin Voltage	±20V	Output Short-Circuit Duration	Indefinite
OUT Pin Voltage	±20V	Operating Junction Temperature Range	
Input to Output Differential Voltage.....	±20V	E, I Grade (Note 2).....	-40°C to 125°C
ADJ Pin Voltage	±7V	MP Grade (Note 2).....	-55°C to 125°C
BYP Pin Voltage	±0.6V	Storage Temperature Range.....	-65°C to 150°C
SHDN Pin Voltage	±20V	Lead Temperature (Soldering, 10 sec)	300°C

PIN CONFIGURATION

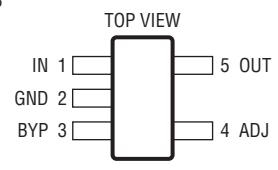
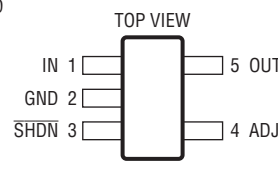
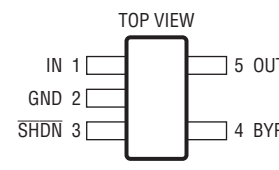
<p>LT1761-BYP</p>  <p>S5 PACKAGE 5-LEAD PLASTIC TSOT-23 $T_{JMAX} = 150^{\circ}C$, $\theta_{JA} = 250^{\circ}C/W$ SEE APPLICATIONS INFORMATION SECTION</p>	<p>LT1761-SD</p>  <p>S5 PACKAGE 5-LEAD PLASTIC TSOT-23 $T_{JMAX} = 150^{\circ}C$, $\theta_{JA} = 250^{\circ}C/W$ SEE APPLICATIONS INFORMATION SECTION</p>	<p>LT1761-X</p>  <p>S5 PACKAGE 5-LEAD PLASTIC TSOT-23 $T_{JMAX} = 150^{\circ}C$, $\theta_{JA} = 250^{\circ}C/W$ SEE APPLICATIONS INFORMATION SECTION</p>
---	--	---

ORDER INFORMATION

LEAD FREE FINISH	TAPE AND REEL	PART MARKING *	PACKAGE DESCRIPTION	TEMPERATURE RANGE
LT1761ES5-BYP#PBF	LT1761ES5-BYP#TRPBF	LTGC	5-Lead Plastic TSOT-23	-40°C to 125°C
LT1761IS5-BYP#PBF	LT1761IS5-BYP#TRPBF	LTGC	5-Lead Plastic TSOT-23	-40°C to 125°C
LT1761ES5-SD#PBF	LT1761ES5-SD#TRPBF	LTGH	5-Lead Plastic TSOT-23	-40°C to 125°C
LT1761IS5-SD#PBF	LT1761IS5-SD#TRPBF	LTGH	5-Lead Plastic TSOT-23	-40°C to 125°C
LT1761ES5-1.2#PBF	LT1761ES5-1.2#TRPBF	LTCDS	5-Lead Plastic TSOT-23	-40°C to 125°C
LT1761IS5-1.2#PBF	LT1761IS5-1.2#TRPBF	LTCDS	5-Lead Plastic TSOT-23	-40°C to 125°C
LT1761ES5-1.5#PBF	LT1761ES5-1.5#TRPBF	LTMT	5-Lead Plastic TSOT-23	-40°C to 125°C
LT1761IS5-1.5#PBF	LT1761IS5-1.5#TRPBF	LTMT	5-Lead Plastic TSOT-23	-40°C to 125°C
LT1761ES5-1.8#PBF	LT1761ES5-1.8#TRPBF	LTJM	5-Lead Plastic TSOT-23	-40°C to 125°C
LT1761IS5-1.8#PBF	LT1761IS5-1.8#TRPBF	LTJM	5-Lead Plastic TSOT-23	-40°C to 125°C
LT1761MPS5-1.8#PBF	LT1761MPS5-1.8#TRPBF	LTDCH	5-Lead Plastic TSOT-23	-55°C to 125°C
LT1761ES5-2#PBF	LT1761ES5-2#TRPBF	LTJE	5-Lead Plastic TSOT-23	-40°C to 125°C
LT1761IS5-2#PBF	LT1761IS5-2#TRPBF	LTJE	5-Lead Plastic TSOT-23	-40°C to 125°C
LT1761ES5-2.5#PBF	LT1761ES5-2.5#TRPBF	LTGD	5-Lead Plastic TSOT-23	-40°C to 125°C
LT1761IS5-2.5#PBF	LT1761IS5-2.5#TRPBF	LTGD	5-Lead Plastic TSOT-23	-40°C to 125°C
LT1761ES5-2.8#PBF	LT1761ES5-2.8#TRPBF	LTLB	5-Lead Plastic TSOT-23	-40°C to 125°C
LT1761IS5-2.8#PBF	LT1761IS5-2.8#TRPBF	LTLB	5-Lead Plastic TSOT-23	-40°C to 125°C
LT1761ES5-3#PBF	LT1761ES5-3#TRPBF	LTGE	5-Lead Plastic TSOT-23	-40°C to 125°C
LT1761IS5-3#PBF	LT1761IS5-3#TRPBF	LTGE	5-Lead Plastic TSOT-23	-40°C to 125°C
LT1761ES5-3.3#PBF	LT1761ES5-3.3#TRPBF	LTGF	5-Lead Plastic TSOT-23	-40°C to 125°C
LT1761IS5-3.3#PBF	LT1761IS5-3.3#TRPBF	LTGF	5-Lead Plastic TSOT-23	-40°C to 125°C
LT1761MPS5-3.3#PBF	LT1761MPS5-3.3#TRPBF	LTGF	5-Lead Plastic TSOT-23	-55°C to 125°C

ORDER INFORMATION

LEAD FREE FINISH	TAPE AND REEL	PART MARKING *	PACKAGE DESCRIPTION	TEMPERATURE RANGE
LT1761ES5-5#PBF	LT1761ES5-5#TRPBF	LTGG	5-Lead Plastic TSOT-23	-40°C to 125°C
LT1761IS5-5#PBF	LT1761IS5-5#TRPBF	LTGG	5-Lead Plastic TSOT-23	-40°C to 125°C
LT1761MPS5-5#PBF	LT1761MPS5-5#TRPBF	LTGG	5-Lead Plastic TSOT-23	-55°C to 125°C
LEAD BASED FINISH	TAPE AND REEL	PART MARKING *	PACKAGE DESCRIPTION	TEMPERATURE RANGE
LT1761ES5-BYP	LT1761ES5-BYP#TR	LTGC	5-Lead Plastic TSOT-23	-40°C to 125°C
LT1761IS5-BYP	LT1761IS5-BYP#TR	LTGC	5-Lead Plastic TSOT-23	-40°C to 125°C
LT1761ES5-SD	LT1761ES5-SD#TR	LTGH	5-Lead Plastic TSOT-23	-40°C to 125°C
LT1761IS5-SD	LT1761IS5-SD#TR	LTGH	5-Lead Plastic TSOT-23	-40°C to 125°C
LT1761ES5-1.2	LT1761ES5-1.2#TR	LTCDS	5-Lead Plastic TSOT-23	-40°C to 125°C
LT1761IS5-1.2	LT1761IS5-1.2#TR	LTCDS	5-Lead Plastic TSOT-23	-40°C to 125°C
LT1761ES5-1.5	LT1761ES5-1.5#TR	LTMT	5-Lead Plastic TSOT-23	-40°C to 125°C
LT1761IS5-1.5	LT1761IS5-1.5#TR	LTMT	5-Lead Plastic TSOT-23	-40°C to 125°C
LT1761ES5-1.8	LT1761ES5-1.8#TR	LTJM	5-Lead Plastic TSOT-23	-40°C to 125°C
LT1761IS5-1.8	LT1761IS5-1.8#TR	LTJM	5-Lead Plastic TSOT-23	-40°C to 125°C
LT1761MPS5-1.8	LT1761MPS5-1.8#TR	LTDC	5-Lead Plastic TSOT-23	-55°C to 125°C
LT1761ES5-2	LT1761ES5-2#TR	LTJE	5-Lead Plastic TSOT-23	-40°C to 125°C
LT1761IS5-2	LT1761IS5-2#TR	LTJE	5-Lead Plastic TSOT-23	-40°C to 125°C
LT1761ES5-2.5	LT1761ES5-2.5#TR	LTGD	5-Lead Plastic TSOT-23	-40°C to 125°C
LT1761IS5-2.5	LT1761IS5-2.5#TR	LTGD	5-Lead Plastic TSOT-23	-40°C to 125°C
LT1761ES5-2.8	LT1761ES5-2.8#TR	LTLB	5-Lead Plastic TSOT-23	-40°C to 125°C
LT1761IS5-2.8	LT1761IS5-2.8#TR	LTLB	5-Lead Plastic TSOT-23	-40°C to 125°C
LT1761ES5-3	LT1761ES5-3#TR	LTGE	5-Lead Plastic TSOT-23	-40°C to 125°C
LT1761IS5-3	LT1761IS5-3#TR	LTGE	5-Lead Plastic TSOT-23	-40°C to 125°C
LT1761ES5-3.3	LT1761ES5-3.3#TR	LTGF	5-Lead Plastic TSOT-23	-40°C to 125°C
LT1761IS5-3.3	LT1761IS5-3.3#TR	LTGF	5-Lead Plastic TSOT-23	-40°C to 125°C
LT1761MPS5-3.3	LT1761MPS5-3.3#TR	LTGF	5-Lead Plastic TSOT-23	-55°C to 125°C
LT1761ES5-5	LT1761ES5-5#TR	LTGG	5-Lead Plastic TSOT-23	-40°C to 125°C
LT1761IS5-5	LT1761IS5-5#TR	LTGG	5-Lead Plastic TSOT-23	-40°C to 125°C
LT1761MPS5-5	LT1761MPS5-5#TR	LTGG	5-Lead Plastic TSOT-23	-55°C to 125°C

Consult LTC Marketing for parts specified with wider operating temperature ranges. *The temperature grade is identified by a label on the shipping container.

For more information on lead free part marking, go to: <http://www.linear.com/leadfree/>

For more information on tape and reel specifications, go to: <http://www.linear.com/tapeandreel/>

ELECTRICAL CHARACTERISTICS The ● denotes the specifications which apply over the full operating temperature range, otherwise specifications are at T_A = 25°C. (Note 2)

PARAMETER	CONDITIONS		MIN	TYP	MAX	UNITS
Minimum Input Voltage (Notes 3, 11)	I _{LOAD} = 100mA ●			1.8	2.3	V
Regulated Output Voltage (Note 4)	LT1761-1.2 V _{IN} = 2V, I _{LOAD} = 1mA 2.3V < V _{IN} < 20V, 1mA < I _{LOAD} < 50mA 2.3V < V _{IN} < 20V, 1mA < I _{LOAD} < 100mA	●	1.185	1.2	1.215	V
		●	1.170	1.2	1.230	V
		●	1.150	1.2	1.240	V
	LT1761-1.5 V _{IN} = 2V, I _{LOAD} = 1mA 2.5V < V _{IN} < 20V, 1mA < I _{LOAD} < 50mA 2.5V < V _{IN} < 20V, 1mA < I _{LOAD} < 100mA	●	1.478	1.5	1.522	V
		●	1.457	1.5	1.538	V
		●	1.436	1.5	1.555	V
	LT1761-1.8 V _{IN} = 2.3V, I _{LOAD} = 1mA 2.8V < V _{IN} < 20V, 1mA < I _{LOAD} < 50mA 2.8V < V _{IN} < 20V, 1mA < I _{LOAD} < 100mA	●	1.775	1.8	1.825	V
		●	1.750	1.8	1.845	V
		●	1.725	1.8	1.860	V
	LT1761-2 V _{IN} = 2.5V, I _{LOAD} = 1mA 3V < V _{IN} < 20V, 1mA < I _{LOAD} < 50mA 3V < V _{IN} < 20V, 1mA < I _{LOAD} < 100mA	●	1.970	2	2.030	V
		●	1.945	2	2.045	V
		●	1.920	2	2.060	V
	LT1761-2.5 V _{IN} = 3V, I _{LOAD} = 1mA 3.5V < V _{IN} < 20V, 1mA < I _{LOAD} < 50mA 3.5V < V _{IN} < 20V, 1mA < I _{LOAD} < 100mA	●	2.465	2.5	2.535	V
		●	2.435	2.5	2.565	V
		●	2.415	2.5	2.575	V
	LT1761-2.8 V _{IN} = 3.3V, I _{LOAD} = 1mA 3.8V < V _{IN} < 20V, 1mA < I _{LOAD} < 50mA 3.8V < V _{IN} < 20V, 1mA < I _{LOAD} < 100mA	●	2.762	2.8	2.838	V
		●	2.732	2.8	2.868	V
		●	2.706	2.8	2.884	V
	LT1761-3 V _{IN} = 3.5V, I _{LOAD} = 1mA 4V < V _{IN} < 20V, 1mA < I _{LOAD} < 50mA 4V < V _{IN} < 20V, 1mA < I _{LOAD} < 100mA	●	2.960	3	3.040	V
		●	2.930	3	3.070	V
●		2.900	3	3.090	V	
LT1761-3.3 V _{IN} = 3.8V, I _{LOAD} = 1mA 4.3V < V _{IN} < 20V, 1mA < I _{LOAD} < 50mA 4.3V < V _{IN} < 20V, 1mA < I _{LOAD} < 100mA	●	3.250	3.3	3.350	V	
	●	3.230	3.3	3.370	V	
	●	3.190	3.3	3.400	V	
LT1761-5 V _{IN} = 5.5V, I _{LOAD} = 1mA 6V < V _{IN} < 20V, 1mA < I _{LOAD} < 50mA 6V < V _{IN} < 20V, 1mA < I _{LOAD} < 100mA	●	4.935	5	5.065	V	
	●	4.900	5	5.100	V	
	●	4.850	5	5.120	V	
ADJ Pin Voltage (Note 3, 4)	LT1761 V _{IN} = 2V, I _{LOAD} = 1mA 2.3V < V _{IN} < 20V, 1mA < I _{LOAD} < 50mA 2.3V < V _{IN} < 20V, 1mA < I _{LOAD} < 100mA	●	1.205	1.220	1.235	V
		●	1.190	1.220	1.250	V
		●	1.170	1.220	1.260	V
Line Regulation	LT1761-1.2	●		1	10	mV
	LT1761-1.5	●		1	10	mV
	LT1761-1.8	●		1	10	mV
	LT1761-2	●		1	10	mV
	LT1761-2.5	●		1	10	mV
	LT1761-2.8	●		1	10	mV
	LT1761-3	●		1	10	mV
	LT1761-3.3	●		1	10	mV
	LT1761-5	●		1	10	mV
	LT1761 (Note 3)	●		1	10	mV

ELECTRICAL CHARACTERISTICS The ● denotes the specifications which apply over the full operating temperature range, otherwise specifications are at $T_A = 25^\circ\text{C}$. (Note 2)

PARAMETER	CONDITIONS	MIN	TYP	MAX	UNITS
Load Regulation	LT1761-1.2 $V_{IN} = 2.3\text{V}, \Delta I_{LOAD} = 1\text{mA to } 50\text{mA}$ $V_{IN} = 2.3\text{V}, \Delta I_{LOAD} = 1\text{mA to } 50\text{mA}$ $V_{IN} = 2.3\text{V}, \Delta I_{LOAD} = 1\text{mA to } 100\text{mA}$ $V_{IN} = 2.3\text{V}, \Delta I_{LOAD} = 1\text{mA to } 100\text{mA}$	●	1	6	mV
				12	mV
		●	1	12	mV
		●		50	mV
	LT1761-1.5 $V_{IN} = 2.5\text{V}, \Delta I_{LOAD} = 1\text{mA to } 50\text{mA}$ $V_{IN} = 2.5\text{V}, \Delta I_{LOAD} = 1\text{mA to } 50\text{mA}$ $V_{IN} = 2.5\text{V}, \Delta I_{LOAD} = 1\text{mA to } 100\text{mA}$ $V_{IN} = 2.5\text{V}, \Delta I_{LOAD} = 1\text{mA to } 100\text{mA}$	●	10	20	mV
				35	mV
		●	14	30	mV
		●		55	mV
	LT1761-1.8 $V_{IN} = 2.8\text{V}, \Delta I_{LOAD} = 1\text{mA to } 50\text{mA}$ $V_{IN} = 2.8\text{V}, \Delta I_{LOAD} = 1\text{mA to } 50\text{mA}$ $V_{IN} = 2.8\text{V}, \Delta I_{LOAD} = 1\text{mA to } 100\text{mA}$ $V_{IN} = 2.8\text{V}, \Delta I_{LOAD} = 1\text{mA to } 100\text{mA}$	●	10	20	mV
				35	mV
		●	15	30	mV
		●		60	mV
	LT1761-2 $V_{IN} = 3\text{V}, \Delta I_{LOAD} = 1\text{mA to } 50\text{mA}$ $V_{IN} = 3\text{V}, \Delta I_{LOAD} = 1\text{mA to } 50\text{mA}$ $V_{IN} = 3\text{V}, \Delta I_{LOAD} = 1\text{mA to } 100\text{mA}$ $V_{IN} = 3\text{V}, \Delta I_{LOAD} = 1\text{mA to } 100\text{mA}$	●	10	20	mV
			35	mV	
●		15	35	mV	
●			65	mV	
LT1761-2.5 $V_{IN} = 3.5\text{V}, \Delta I_{LOAD} = 1\text{mA to } 50\text{mA}$ $V_{IN} = 3.5\text{V}, \Delta I_{LOAD} = 1\text{mA to } 50\text{mA}$ $V_{IN} = 3.5\text{V}, \Delta I_{LOAD} = 1\text{mA to } 100\text{mA}$ $V_{IN} = 3.5\text{V}, \Delta I_{LOAD} = 1\text{mA to } 100\text{mA}$	●	10	20	mV	
			35	mV	
	●	20	40	mV	
	●		80	mV	
LT1761-2.8 $V_{IN} = 3.8\text{V}, \Delta I_{LOAD} = 1\text{mA to } 50\text{mA}$ $V_{IN} = 3.8\text{V}, \Delta I_{LOAD} = 1\text{mA to } 50\text{mA}$ $V_{IN} = 3.8\text{V}, \Delta I_{LOAD} = 1\text{mA to } 100\text{mA}$ $V_{IN} = 3.8\text{V}, \Delta I_{LOAD} = 1\text{mA to } 100\text{mA}$	●	10	20	mV	
			38	mV	
	●	20	40	mV	
	●		86	mV	
LT1761-3 $V_{IN} = 4\text{V}, \Delta I_{LOAD} = 1\text{mA to } 50\text{mA}$ $V_{IN} = 4\text{V}, \Delta I_{LOAD} = 1\text{mA to } 50\text{mA}$ $V_{IN} = 4\text{V}, \Delta I_{LOAD} = 1\text{mA to } 100\text{mA}$ $V_{IN} = 4\text{V}, \Delta I_{LOAD} = 1\text{mA to } 100\text{mA}$	●	10	20	mV	
			40	mV	
	●	20	40	mV	
	●		90	mV	
LT1761-3.3 $V_{IN} = 4.3\text{V}, \Delta I_{LOAD} = 1\text{mA to } 50\text{mA}$ $V_{IN} = 4.3\text{V}, \Delta I_{LOAD} = 1\text{mA to } 50\text{mA}$ $V_{IN} = 4.3\text{V}, \Delta I_{LOAD} = 1\text{mA to } 100\text{mA}$ $V_{IN} = 4.3\text{V}, \Delta I_{LOAD} = 1\text{mA to } 100\text{mA}$	●	10	20	mV	
			40	mV	
	●	20	40	mV	
	●		100	mV	
LT1761-5 $V_{IN} = 6\text{V}, \Delta I_{LOAD} = 1\text{mA to } 50\text{mA}$ $V_{IN} = 6\text{V}, \Delta I_{LOAD} = 1\text{mA to } 50\text{mA}$ $V_{IN} = 6\text{V}, \Delta I_{LOAD} = 1\text{mA to } 100\text{mA}$ $V_{IN} = 6\text{V}, \Delta I_{LOAD} = 1\text{mA to } 100\text{mA}$	●	15	30	mV	
			60	mV	
	●	25	65	mV	
	●		150	mV	
LT1761 (Note 3) $V_{IN} = 2.3\text{V}, \Delta I_{LOAD} = 1\text{mA to } 50\text{mA}$ $V_{IN} = 2.3\text{V}, \Delta I_{LOAD} = 1\text{mA to } 50\text{mA}$ $V_{IN} = 2.3\text{V}, \Delta I_{LOAD} = 1\text{mA to } 100\text{mA}$ $V_{IN} = 2.3\text{V}, \Delta I_{LOAD} = 1\text{mA to } 100\text{mA}$	●	1	6	mV	
			12	mV	
	●	1	12	mV	
	●		50	mV	
Dropout Voltage $V_{IN} = V_{OUT(NOMINAL)}$ (Notes 5, 6, 11)	$I_{LOAD} = 1\text{mA}$ $I_{LOAD} = 1\text{mA}$	●	0.10	0.15	V
				0.19	V
	$I_{LOAD} = 10\text{mA}$ $I_{LOAD} = 10\text{mA}$	●	0.17	0.22	V
				0.29	V
$I_{LOAD} = 50\text{mA}$ $I_{LOAD} = 50\text{mA}$	●	0.24	0.28	V	
			0.38	V	
$I_{LOAD} = 100\text{mA}$ $I_{LOAD} = 100\text{mA}$		0.30	0.35	V	
			0.45	V	

ELECTRICAL CHARACTERISTICS The ● denotes the specifications which apply over the full operating temperature range, otherwise specifications are at $T_A = 25^\circ\text{C}$. (Note 2)

PARAMETER	CONDITIONS	MIN	TYP	MAX	UNITS
GND Pin Current $V_{IN} = V_{OUT(NOMINAL)}$ (Notes 5, 7)	$I_{LOAD} = 0\text{mA}$ ●		20	45	μA
	$I_{LOAD} = 1\text{mA}$ ●		55	100	μA
	$I_{LOAD} = 10\text{mA}$ ●		230	400	μA
	$I_{LOAD} = 50\text{mA}$ ●		1	2	mA
	$I_{LOAD} = 100\text{mA}$ ●		2.2	4	mA
Output Voltage Noise	$C_{OUT} = 10\mu\text{F}$, $C_{BYP} = 0.01\mu\text{F}$, $I_{LOAD} = 100\text{mA}$, $\text{BW} = 10\text{Hz to } 100\text{kHz}$		20		μV_{RMS}
ADJ Pin Bias Current	(Notes 3, 8)		30	100	nA
Shutdown Threshold	$V_{OUT} = \text{Off to On}$ ●		0.8	2	V
	$V_{OUT} = \text{On to Off}$ ●	0.25	0.65		V
SHDN Pin Current (Note 9)	$V_{SHDN} = 0\text{V}$ ●		0	0.5	μA
	$V_{SHDN} = 20\text{V}$ ●		1	3	μA
Quiescent Current in Shutdown	$V_{IN} = 6\text{V}$, $V_{SHDN} = 0\text{V}$		0.01	0.1	μA
Ripple Rejection (Note 3)	$V_{IN} - V_{OUT} = 1.5\text{V (Avg)}$, $V_{\text{RIPPLE}} = 0.5\text{V}_{\text{P-P}}$, $f_{\text{RIPPLE}} = 120\text{Hz}$, $I_{LOAD} = 50\text{mA}$	55	65		dB
Current Limit	$V_{IN} = 7\text{V}$, $V_{OUT} = 0\text{V}$		200		mA
	$V_{IN} = V_{OUT(NOMINAL)} + 1\text{V or } 2.3\text{V (Note 12)}$, $\Delta V_{OUT} = -5\%$ ●	110			mA
Input Reverse Leakage Current	$V_{IN} = -20\text{V}$, $V_{OUT} = 0\text{V}$ ●			1	mA
Reverse Output Current (Note 10)	LT1761-1.2 $V_{OUT} = 1.2\text{V}$, $V_{IN} < 1.2\text{V}$		10	20	μA
	LT1761-1.5 $V_{OUT} = 1.5\text{V}$, $V_{IN} < 1.5\text{V}$		10	20	μA
	LT1761-1.8 $V_{OUT} = 1.8\text{V}$, $V_{IN} < 1.8\text{V}$		10	20	μA
	LT1761-2 $V_{OUT} = 2\text{V}$, $V_{IN} < 2\text{V}$		10	20	μA
	LT1761-2.5 $V_{OUT} = 2.5\text{V}$, $V_{IN} < 2.5\text{V}$		10	20	μA
	LT1761-2.8 $V_{OUT} = 2.8\text{V}$, $V_{IN} < 2.8\text{V}$		10	20	μA
	LT1761-3 $V_{OUT} = 3\text{V}$, $V_{IN} < 3\text{V}$		10	20	μA
	LT1761-3.3 $V_{OUT} = 3.3\text{V}$, $V_{IN} < 3.3\text{V}$		10	20	μA
	LT1761-5 $V_{OUT} = 5\text{V}$, $V_{IN} < 5\text{V}$		10	20	μA
	LT1761 (Note 3) $V_{OUT} = 1.22\text{V}$, $V_{IN} < 1.22\text{V}$		5	10	μA

Note 1: Stresses beyond those listed under Absolute Maximum Ratings may cause permanent damage to the device. Exposure to any Absolute Maximum Rating condition for extended periods may affect device reliability and lifetime.

Note 2: The LT1761 regulators are tested and specified under pulse load conditions such that $T_J \approx T_A$. The LT1761E is 100% production tested at $T_A = 25^\circ\text{C}$. Performance at -40°C and 125°C is assured by design, characterization and correlation with statistical process controls. The LT1761I is guaranteed over the full -40°C to 125°C operating junction temperature range. The LT1761MP is 100% tested and guaranteed over the -55°C to 125°C operating junction temperature range.

Note 3: The LT1761 (adjustable versions) are tested and specified for these conditions with the ADJ pin connected to the OUT pin.

Note 4: Operating conditions are limited by maximum junction temperature. The regulated output voltage specification will not apply for all possible combinations of input voltage and output current. When operating at maximum input voltage, the output current range must be limited. When operating at maximum output current, the input voltage range must be limited.

Note 5: To satisfy requirements for minimum input voltage, the LT1761 (adjustable version) is tested and specified for these conditions with an external resistor divider (two 250k resistors) for an output voltage of 2.44V. The external resistor divider will add a 5 μA DC load on the output.

Note 6: Dropout voltage is the minimum input to output voltage differential needed to maintain regulation at a specified output current. In dropout, the output voltage will be equal to: $V_{IN} - V_{\text{DROPOUT}}$.

Note 7: GND pin current is tested with $V_{IN} = V_{OUT(NOMINAL)}$ or $V_{IN} = 2.3\text{V}$ (whichever is greater) and a current source load. This means the device is tested while operating in its dropout region or at the minimum input voltage specification. This is the worst-case GND pin current. The GND pin current will decrease slightly at higher input voltages.

Note 8: ADJ pin bias current flows into the ADJ pin.

Note 9: SHDN pin current flows into the SHDN pin.

Note 10: Reverse output current is tested with the IN pin grounded and the OUT pin forced to the rated output voltage. This current flows into the OUT pin and out the GND pin.

Note 11: For the LT1761, LT1761-1.2, LT1761-1.5, LT1761-1.8 and LT1761-2 dropout voltage will be limited by the minimum input voltage specification under some output voltage/load conditions. See the curve of Minimum Input Voltage in the Typical Performance Characteristics.

Note 12: To satisfy requirements for minimum input voltage, current limit is tested at $V_{IN} = V_{OUT(NOMINAL)} + 1\text{V}$ or $V_{IN} = 2.3\text{V}$, whichever is greater.

TYPICAL PERFORMANCE CHARACTERISTICS

Typical Dropout Voltage

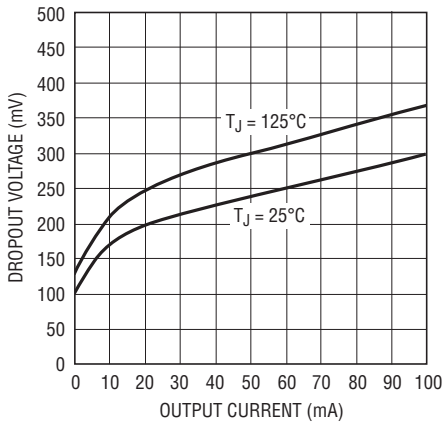

1761 G00

Guaranteed Dropout Voltage

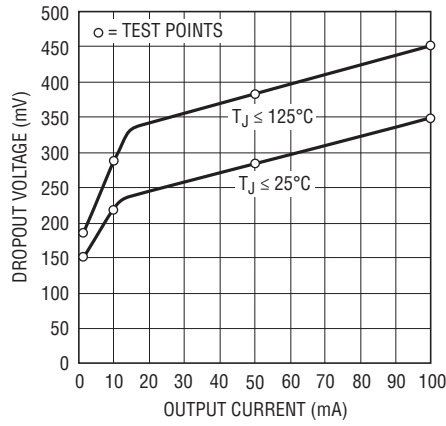

1761 G01

Dropout Voltage

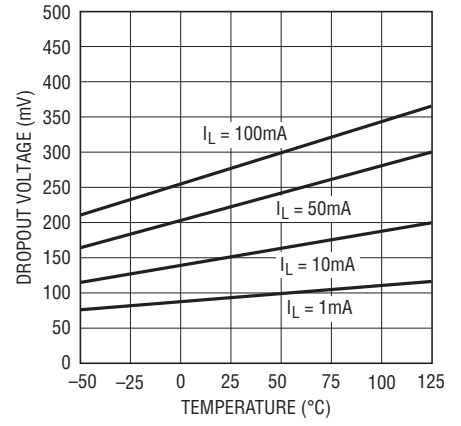

1761 G01.1

Quiescent Current

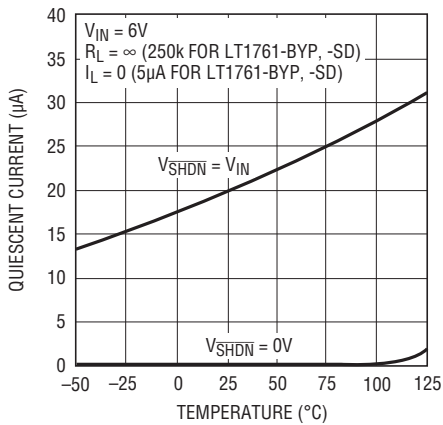

1761 G03

LT1761-1.2 Output Voltage

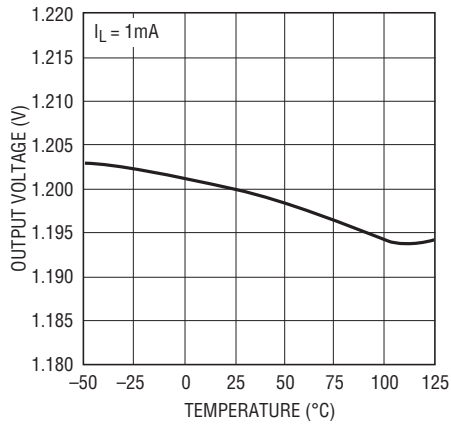

1761 G05

LT1761-1.5 Output Voltage

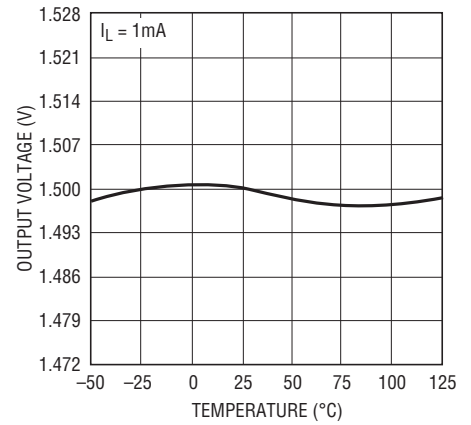

1761 G51

LT1761-1.8 Output Voltage

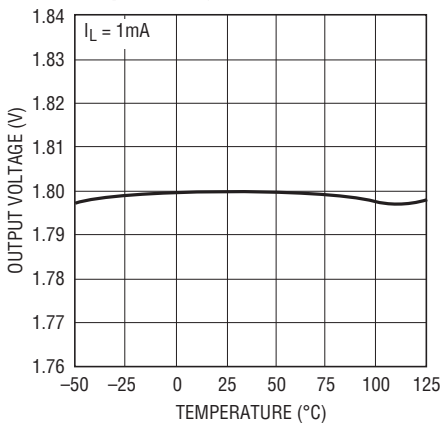

1761 G06

LT1761-2 Output Voltage

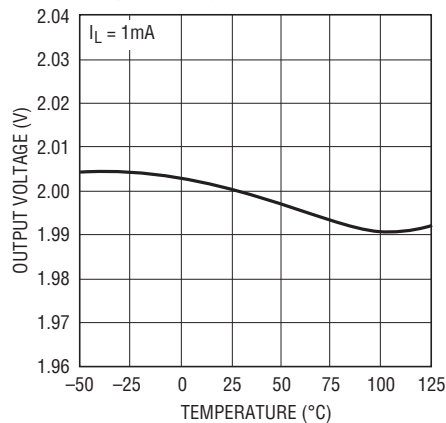

1761 G07

LT1761-2.5 Output Voltage

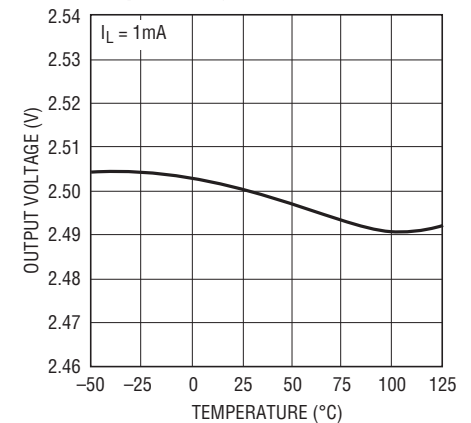

1761 G08

TYPICAL PERFORMANCE CHARACTERISTICS

**LT1761-2.8
Output Voltage**

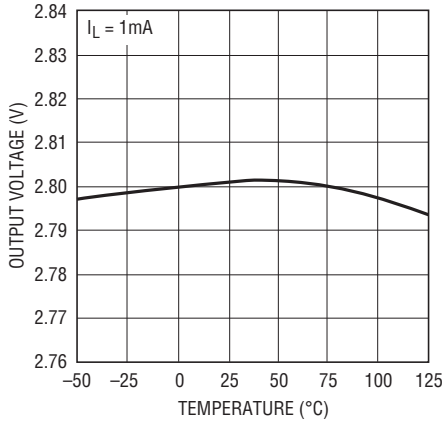

**LT1761-3
Output Voltage**

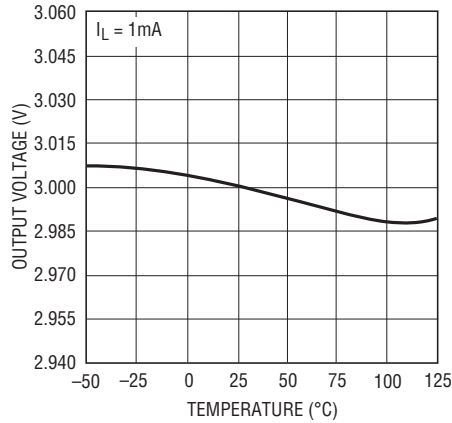

**LT1761-3.3
Output Voltage**

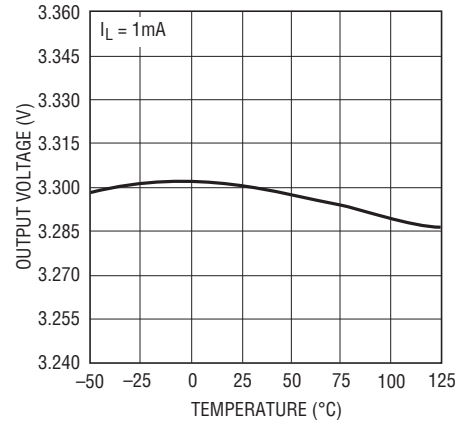

**LT1761-5
Output Voltage**

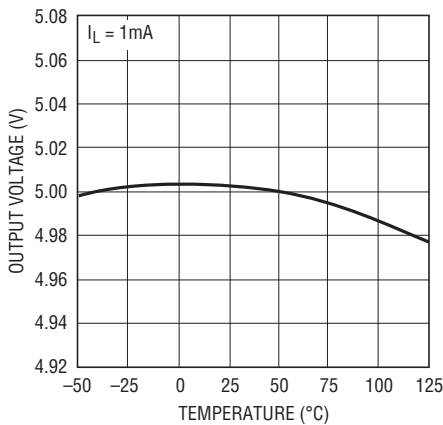

**LT1761-BYP, LT1761-SD
ADJ Pin Voltage**

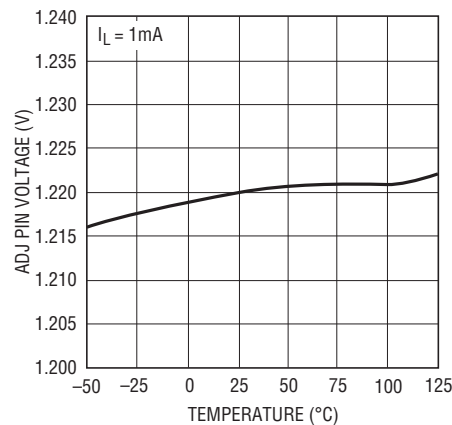

**LT1761-1.2
Quiescent Current**

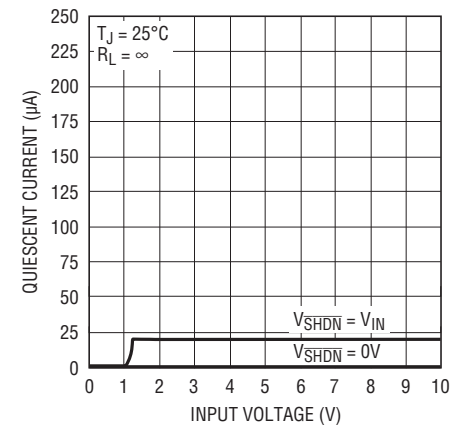

**LT1761-1.5
Quiescent Current**

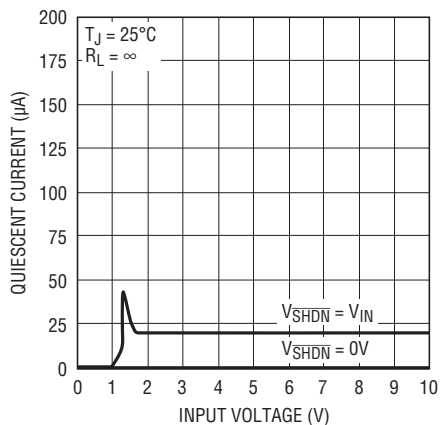

**LT1761-1.8
Quiescent Current**

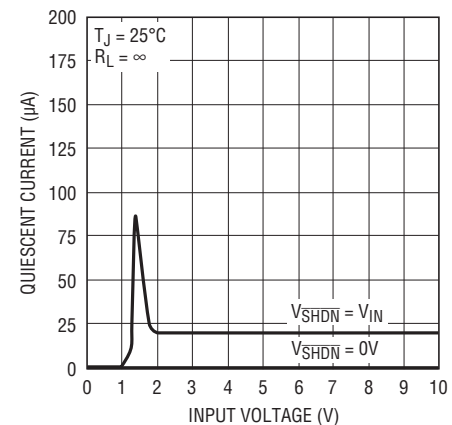

**LT1761-2
Quiescent Current**

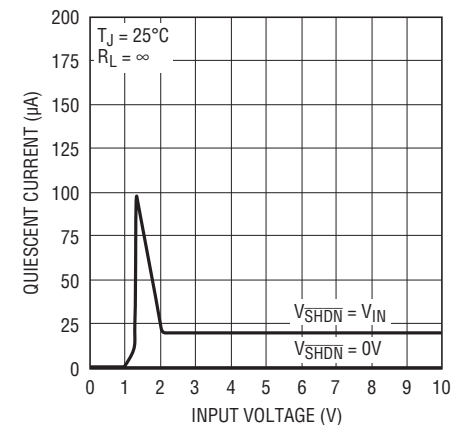

TYPICAL PERFORMANCE CHARACTERISTICS

**LT1761-2.5
Quiescent Current**

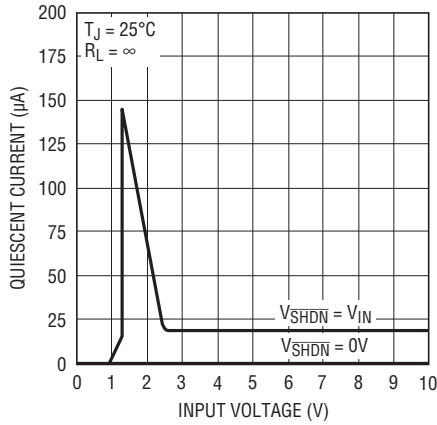

1761 G13

**LT1761-2.8
Quiescent Current**

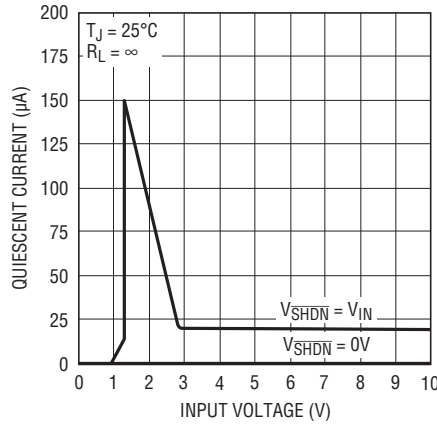

1761 G54

**LT1761-3
Quiescent Current**

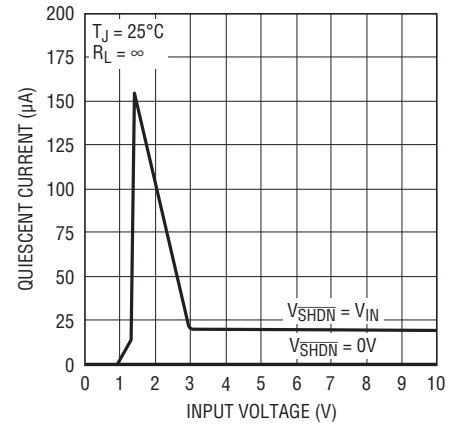

1761 G14

**LT1761-3.3
Quiescent Current**

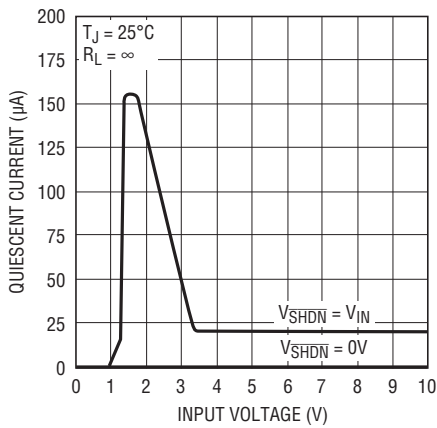

1761 G15

**LT1761-5
Quiescent Current**

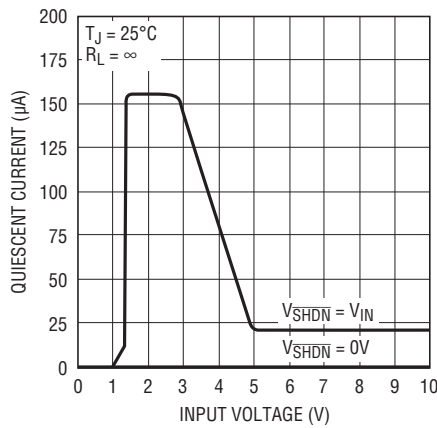

1761 G16

**LT1761-BYP, LT1761-SD
Quiescent Current**

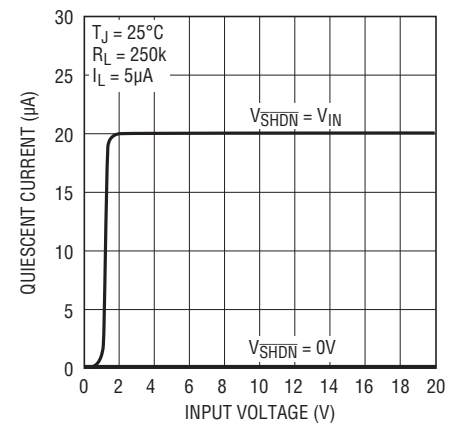

1761 G17

**LT1761-1.2
GND Pin Current**

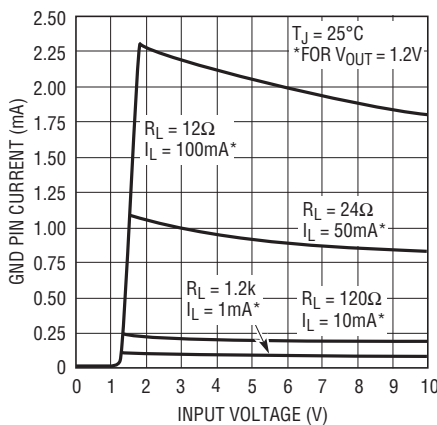

1761 G17b

**LT1761-1.5
GND Pin Current**

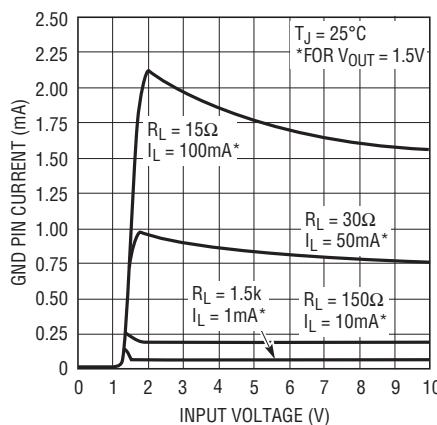

1761 G55

**LT1761-1.8
GND Pin Current**

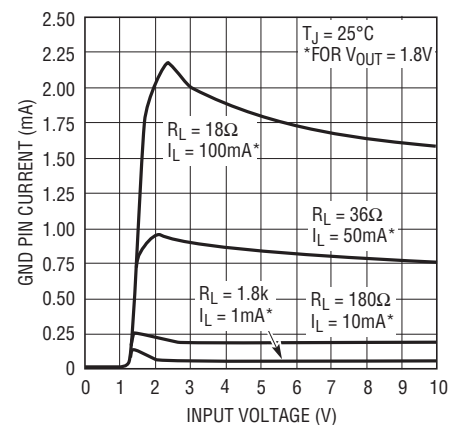

1761 G02

TYPICAL PERFORMANCE CHARACTERISTICS

LT1761-2
GND Pin Current

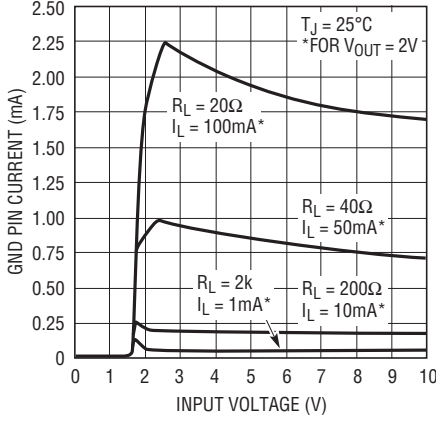

1761 G04

LT1761-2.5
GND Pin Current

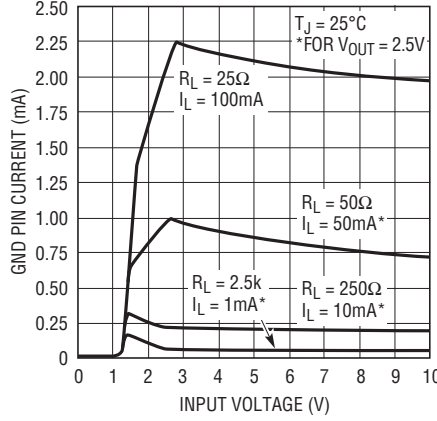

1761 G20

LT1761-2.8
GND Pin Current

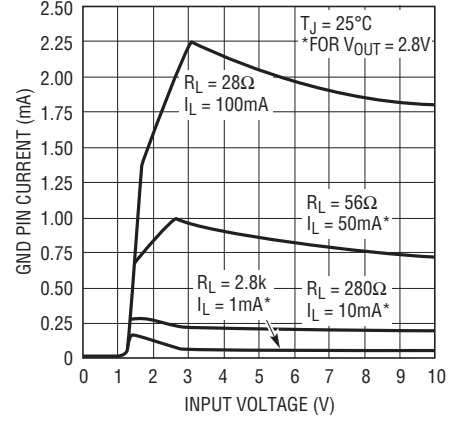

1761 G56

LT1761-3
GND Pin Current

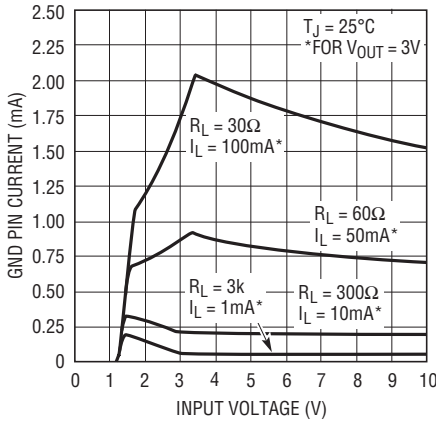

1761 G21

LT1761-3.3
GND Pin Current

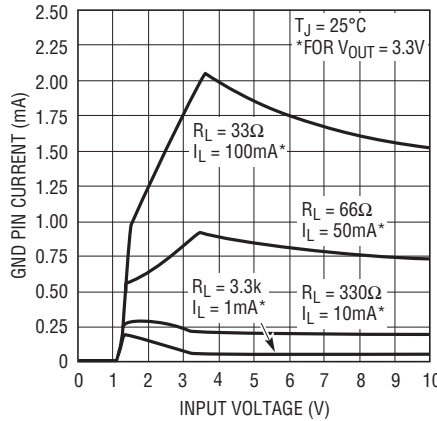

1761 G22

LT1761-5
GND Pin Current

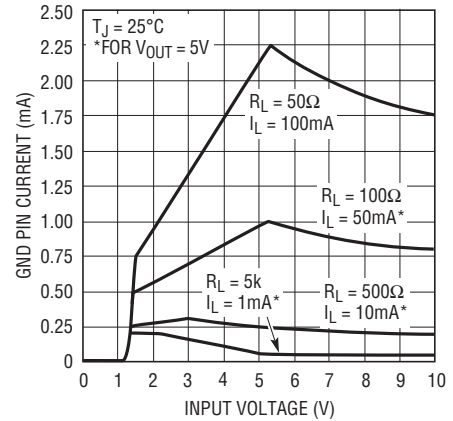

1761 G23

LT1761-BYP, LT1761-SD
GND Pin Current

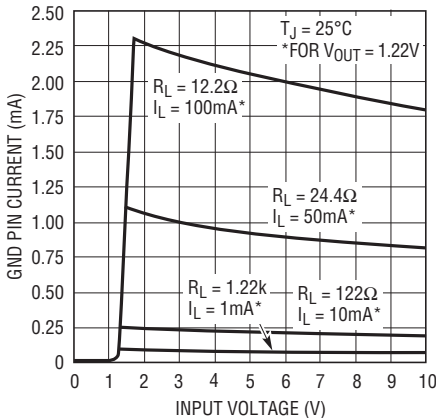

1761 G24

GND Pin Current vs ILOAD

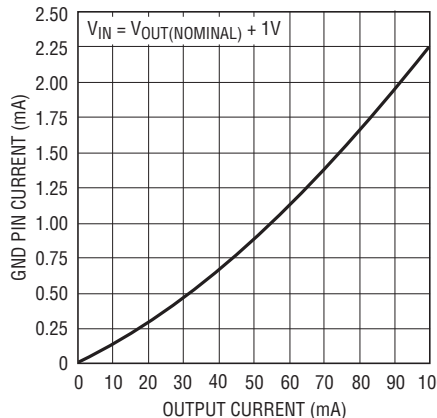

1761 G25

SHDN Pin Threshold
(On to Off)

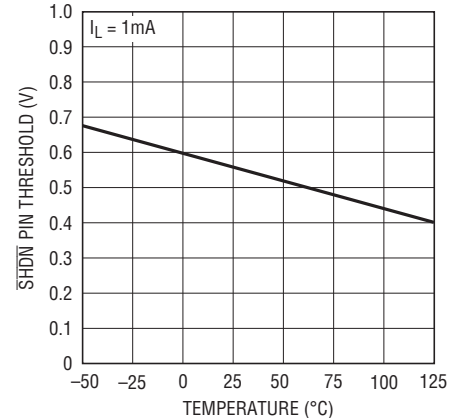

1761 G26

TYPICAL PERFORMANCE CHARACTERISTICS

SHDN Pin Threshold (Off to On)

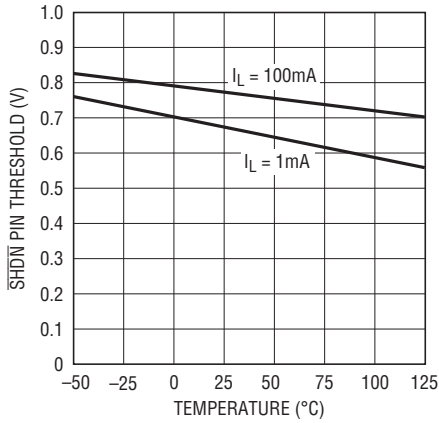

1761 G27

SHDN Pin Input Current

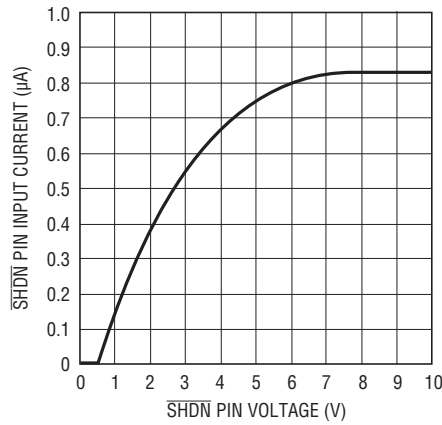

1761 G28

SHDN Pin Input Current

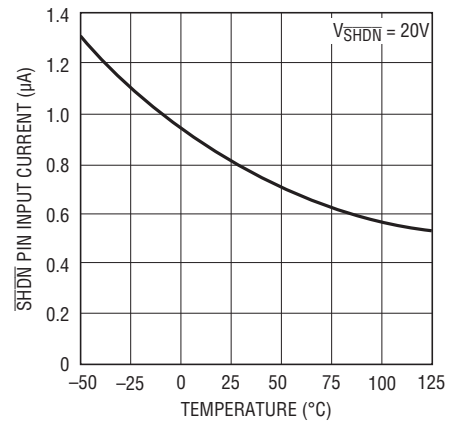

1761 G29

ADJ Pin Bias Current

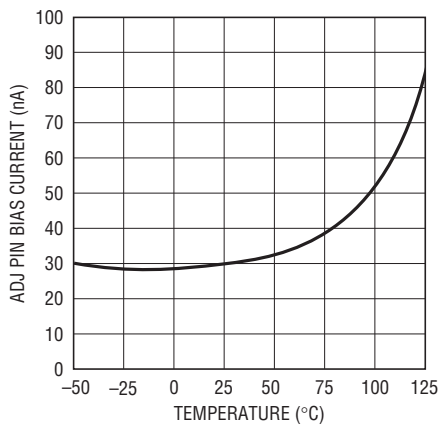

1761 G30

Current Limit

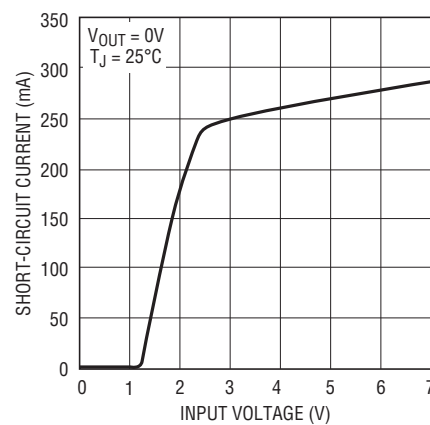

1761 G31

Current Limit

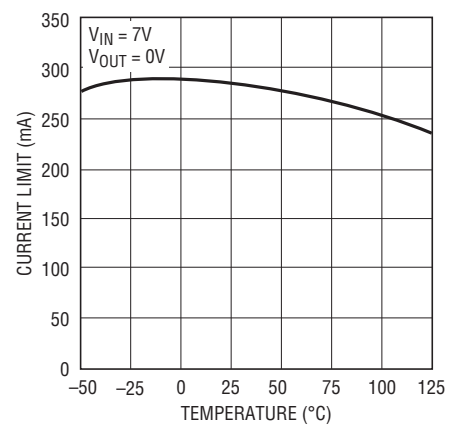

1761 G32

Reverse Output Current

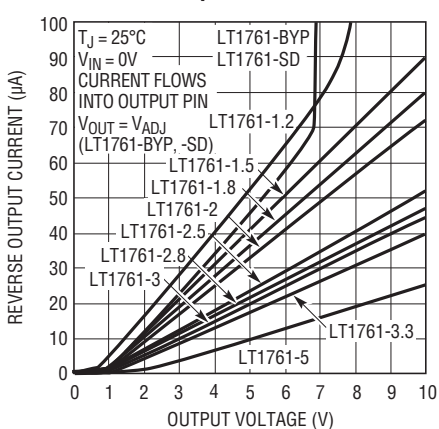

1761 G33

Reverse Output Current

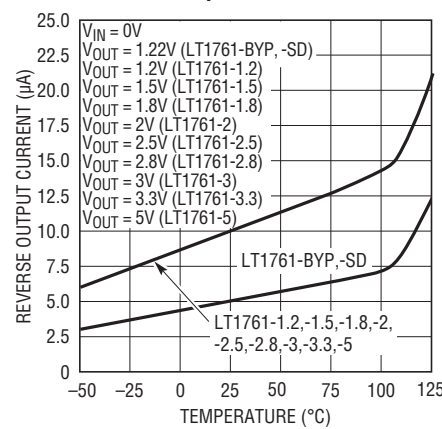

1761 G34

Input Ripple Rejection

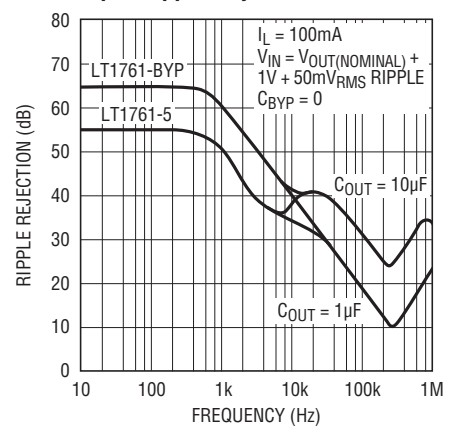

1761 G35

TYPICAL PERFORMANCE CHARACTERISTICS

**LT1761-5
Input Ripple Rejection**

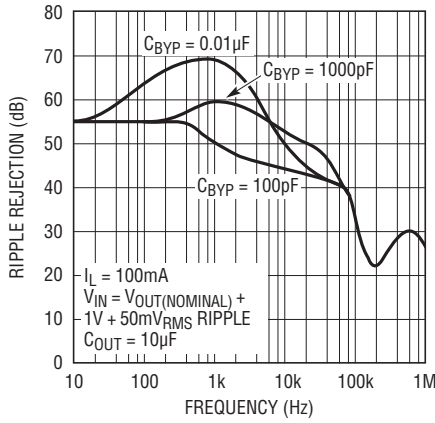

1761 G36

Input Ripple Rejection

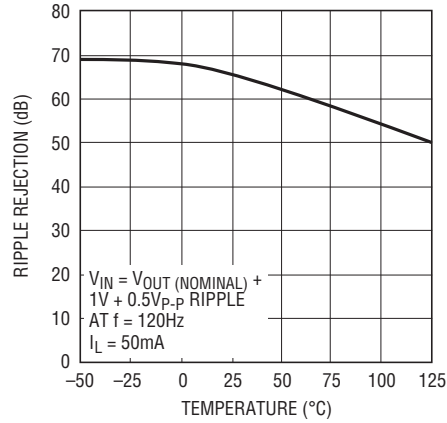

1761 G37

**LT1761-BYP, LT1761-SD
Minimum Input Voltage**

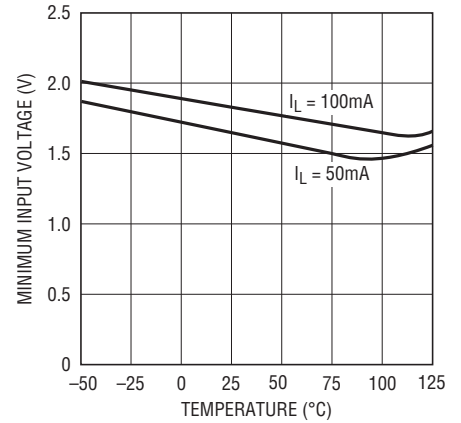

1761 G38

**Load Regulation
ΔI_L = 1mA to 50mA**

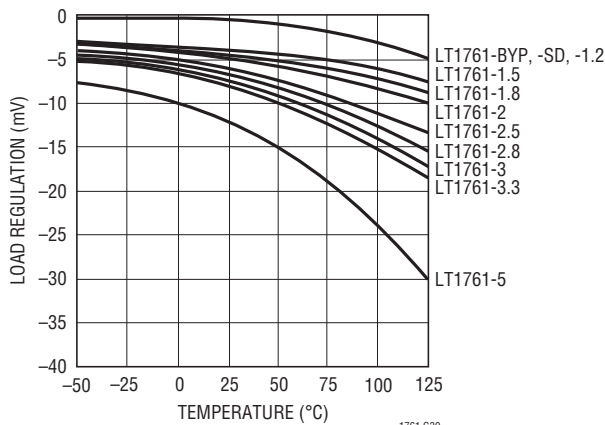

1761 G39

**Load Regulation
ΔI_L = 1mA to 100mA**

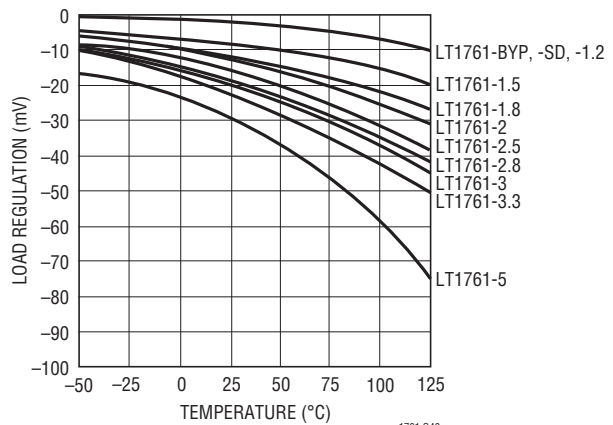

1761 G40

Output Noise Spectral Density

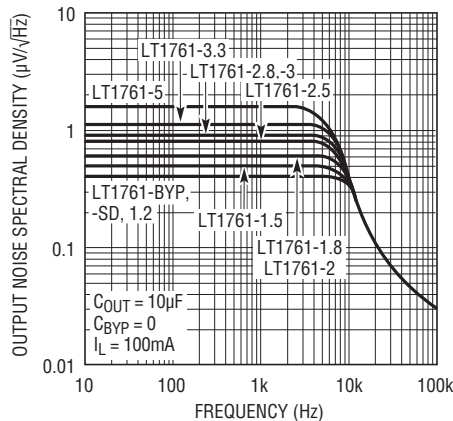

1761 G41

Output Noise Spectral Density

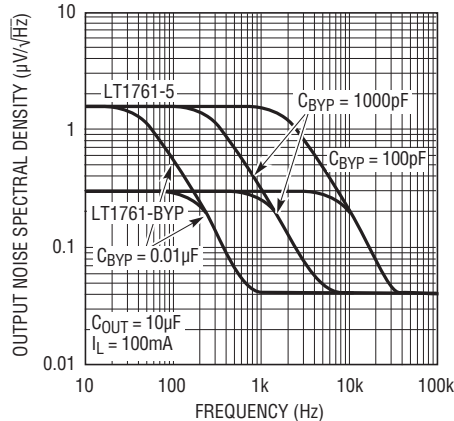

1761 G42

**RMS Output Noise vs
Bypass Capacitor**

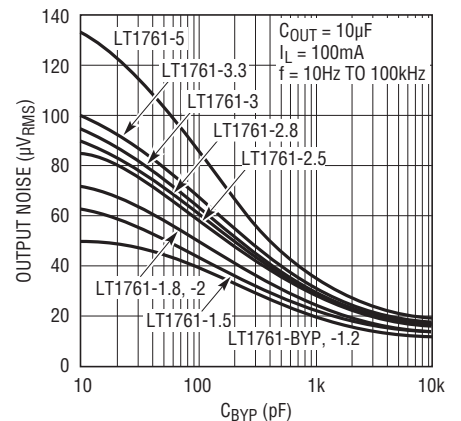

1761 G43

1761sff

TYPICAL PERFORMANCE CHARACTERISTICS

RMS Output Noise vs Load Current (10Hz to 100kHz)

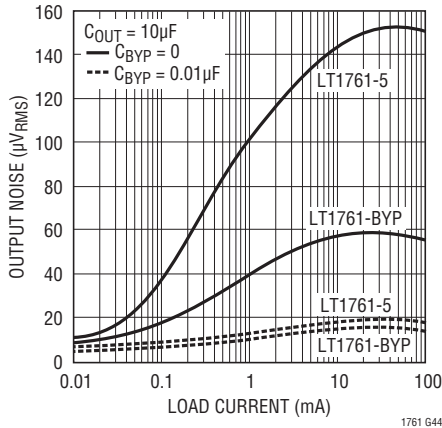

**LT1761-5
10Hz to 100kHz Output Noise
 $C_{BYP} = 0pF$**

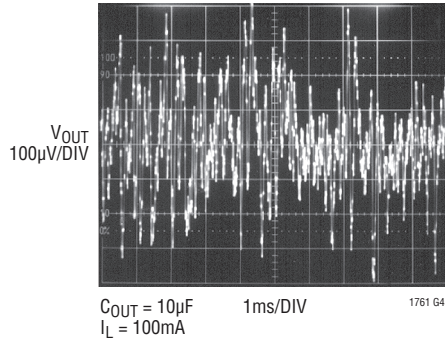

**LT1761-5
10Hz to 100kHz Output Noise
 $C_{BYP} = 100pF$**

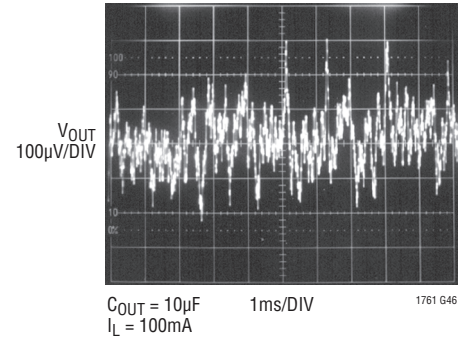

**LT1761-5
10Hz to 100kHz Output Noise
 $C_{BYP} = 1000pF$**

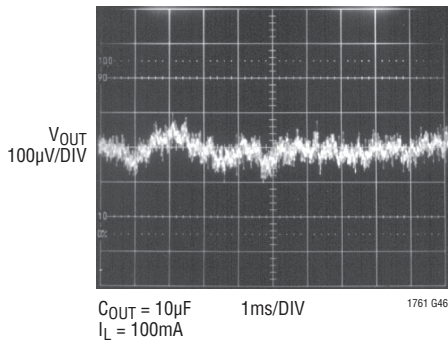

**LT1761-5
10Hz to 100kHz Output Noise
 $C_{BYP} = 0.01\mu F$**

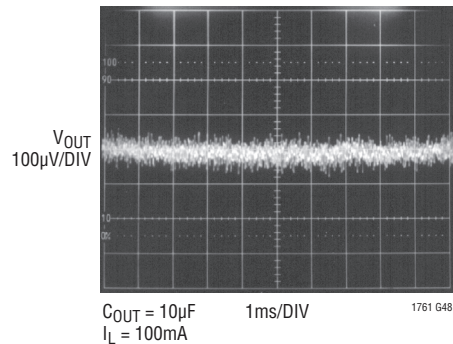

**LT1761-5 Transient Response
 $C_{BYP} = 0pF$**

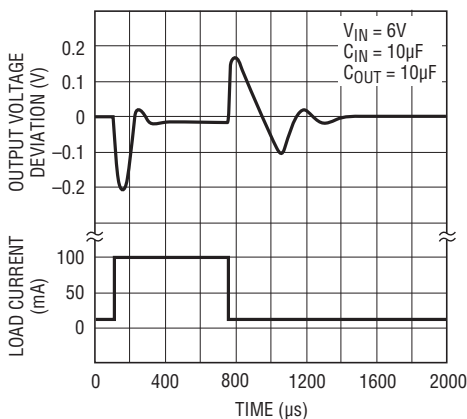

**LT1761-5 Transient Response
 $C_{BYP} = 0.01\mu F$**

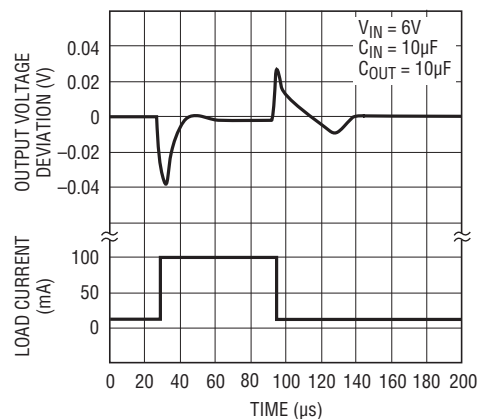

PIN FUNCTIONS

IN (Pin 1): Input. Power is supplied to the device through the IN pin. A bypass capacitor is required on this pin if the device is more than six inches away from the main input filter capacitor. In general, the output impedance of a battery rises with frequency, so it is advisable to include a bypass capacitor in battery-powered circuits. A bypass capacitor in the range of $1\mu\text{F}$ to $10\mu\text{F}$ is sufficient. The LT1761 regulators are designed to withstand reverse voltages on the IN pin with respect to ground and the OUT pin. In the case of a reverse input, which can happen if a battery is plugged in backwards, the device will act as if there is a diode in series with its input. There will be no reverse current flow into the regulator and no reverse voltage will appear at the load. The device will protect both itself and the load.

GND (Pin 2): Ground.

$\overline{\text{SHDN}}$ (Pin 3, Fixed/-SD Devices): Shutdown. The $\overline{\text{SHDN}}$ pin is used to put the LT1761 regulators into a low power shutdown state. The output will be off when the $\overline{\text{SHDN}}$ pin is pulled low. The $\overline{\text{SHDN}}$ pin can be driven either by 5V logic or open-collector logic with a pull-up resistor. The pull-up resistor is required to supply the pull-up current of the open-collector gate, normally several microamperes, and the $\overline{\text{SHDN}}$ pin current, typically $1\mu\text{A}$. If unused, the $\overline{\text{SHDN}}$ pin must be connected to V_{IN} . The device will not function if the $\overline{\text{SHDN}}$ pin is not connected. For the LT1761-BYP, the $\overline{\text{SHDN}}$ pin is internally connected to V_{IN} .

BYP (Pins 3/4, Fixed/-BYP Devices): Bypass. The BYP pin is used to bypass the reference of the LT1761 regulators to achieve low noise performance from the regulator. The BYP pin is clamped internally to $\pm 0.6\text{V}$ (one V_{BE}) from ground. A small capacitor from the output to this pin will bypass the reference to lower the output voltage noise. A maximum value of $0.01\mu\text{F}$ can be used for reducing output voltage noise to a typical $20\mu\text{V}_{\text{RMS}}$ over a 10Hz to 100kHz bandwidth. If not used, this pin must be left unconnected.

ADJ (Pin 4, Adjustable Devices Only): Adjust Pin. For the adjustable LT1761, this is the input to the error amplifier. This pin is internally clamped to $\pm 7\text{V}$. It has a bias current of 30nA which flows into the pin (see curve of ADJ Pin Bias Current vs Temperature in the Typical Performance Characteristics section). The ADJ pin voltage is 1.22V referenced to ground and the output voltage range is 1.22V to 20V .

OUT (Pin 5): Output. The output supplies power to the load. A minimum output capacitor of $1\mu\text{F}$ is required to prevent oscillations. Larger output capacitors will be required for applications with large transient loads to limit peak voltage transients. See the Applications Information section for more information on output capacitance and reverse output characteristics.

APPLICATIONS INFORMATION

The LT1761 series are 100mA low dropout regulators with micropower quiescent current and shutdown. The devices are capable of supplying 100mA at a dropout voltage of 300mV. Output voltage noise can be lowered to 20µV_{RMS} over a 10Hz to 100kHz bandwidth with the addition of a 0.01µF reference bypass capacitor. Additionally, the reference bypass capacitor will improve transient response of the regulator, lowering the settling time for transient load conditions. The low operating quiescent current (20µA) drops to less than 1µA in shutdown. In addition to the low quiescent current, the LT1761 regulators incorporate several protection features which make them ideal for use in battery-powered systems. The devices are protected against both reverse input and reverse output voltages. In battery backup applications where the output can be held up by a backup battery when the input is pulled to ground, the LT1761-X acts like it has a diode in series with its output and prevents reverse current flow. Additionally, in dual supply applications where the regulator load is returned to a negative supply, the output can be pulled below ground by as much as 20V and still allow the device to start and operate.

Adjustable Operation

The adjustable version of the LT1761 has an output voltage range of 1.22V to 20V. The output voltage is set by the ratio of two external resistors as shown in Figure 1. The device servos the output to maintain the ADJ pin voltage at 1.22V referenced to ground. The current in R1 is then equal to 1.22V/R1 and the current in R2 is the current in R1 plus the ADJ pin bias current. The ADJ pin bias current, 30nA at 25°C, flows through R2 into the ADJ pin. The output voltage can be calculated using the formula in Figure 1. The value of R1 should be no greater than 250k to minimize errors in the output voltage caused by the

ADJ pin bias current. Note that in shutdown the output is turned off and the divider current will be zero. Curves of ADJ Pin Voltage vs Temperature and ADJ Pin Bias Current vs Temperature appear in the Typical Performance Characteristics.

The adjustable device is tested and specified with the ADJ pin tied to the OUT pin for an output voltage of 1.22V. Specifications for output voltages greater than 1.22V will be proportional to the ratio of the desired output voltage to 1.22V: $V_{OUT}/1.22V$. For example, load regulation for an output current change of 1mA to 100mA is -1mV typical at $V_{OUT} = 1.22V$. At $V_{OUT} = 12V$, load regulation is:

$$(12V/1.22V)(-1mV) = -9.8mV$$

Bypass Capacitance and Low Noise Performance

The LT1761 regulators may be used with the addition of a bypass capacitor from OUT to the BYP pin to lower output voltage noise. A good quality low leakage capacitor is recommended. This capacitor will bypass the reference of the regulator, providing a low frequency noise pole. The noise pole provided by this bypass capacitor will lower the output voltage noise to as low as 20µV_{RMS} with the addition of a 0.01µF bypass capacitor. Using a bypass capacitor has the added benefit of improving transient response. With no bypass capacitor and a 10µF output capacitor, a 10mA to 100mA load step will settle to within 1% of its final value in less than 100µs. With the addition of a 0.01µF bypass capacitor, the output will stay within 1% for a 10mA to 100mA load step (see LT1761-5 Transient Response in Typical Performance Characteristics section). However, regulator start-up time is proportional to the size of the bypass capacitor, slowing to 15ms with a 0.01µF bypass capacitor and 10µF output capacitor.

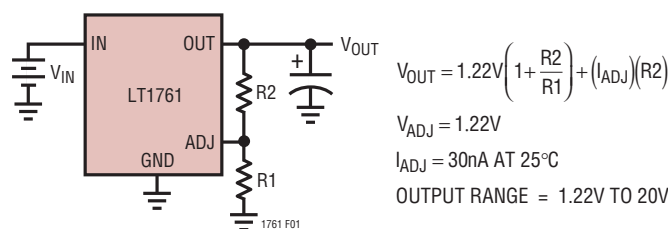

Figure 1. Adjustable Operation

APPLICATIONS INFORMATION

Output Capacitance and Transient Response

The LT1761 regulators are designed to be stable with a wide range of output capacitors. The ESR of the output capacitor affects stability, most notably with small capacitors. A minimum output capacitor of $1\mu\text{F}$ with an ESR of 3Ω or less is recommended to prevent oscillations. The LT1761-X is a micropower device and output transient response will be a function of output capacitance. Larger values of output capacitance decrease the peak deviations and provide improved transient response for larger load current changes. Bypass capacitors, used to decouple individual components powered by the LT1761-X, will increase the effective output capacitor value. With larger capacitors used to bypass the reference (for low noise operation), larger values of output capacitors are needed. For 100pF of bypass capacitance, $2.2\mu\text{F}$ of output capacitor is recommended. With a 330pF bypass capacitor or larger, a $3.3\mu\text{F}$ output capacitor is recommended. The shaded region of Figure 2 defines the region over which the LT1761 regulators are stable. The minimum ESR needed is defined by the amount of bypass capacitance used, while the maximum ESR is 3Ω .

Extra consideration must be given to the use of ceramic capacitors. Ceramic capacitors are manufactured with a variety of dielectrics, each with different behavior across temperature and applied voltage. The most common dielectrics used are specified with EIA temperature characteristic codes of Z5U, Y5V, X5R and X7R. The Z5U and Y5V dielectrics are good for providing high capacitances in a small package, but they tend to have strong voltage

and temperature coefficients as shown in Figures 3 and 4. When used with a 5V regulator, a $16\text{V } 10\mu\text{F Y5V}$ capacitor can exhibit an effective value as low as $1\mu\text{F}$ to $2\mu\text{F}$ for the DC bias voltage applied and over the operating temperature range. The X5R and X7R dielectrics result in more stable characteristics and are more suitable for use as the output capacitor. The X7R type has better stability across temperature, while the X5R is less expensive and is available in higher values. Care still must be exercised when using X5R and X7R capacitors; the X5R and X7R codes only specify operating temperature range and maximum capacitance change over temperature. Capacitance change due to DC bias with X5R and X7R capacitors is better than Y5V and Z5U capacitors, but can still be significant enough to drop capacitor values below appropriate levels. Capacitor DC bias characteristics tend to improve as component case size increases, but expected capacitance at operating voltage should be verified.

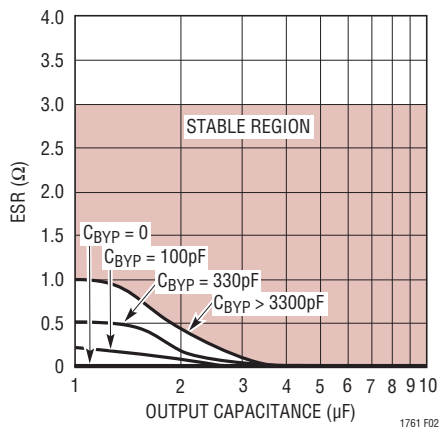

Figure 2. Stability

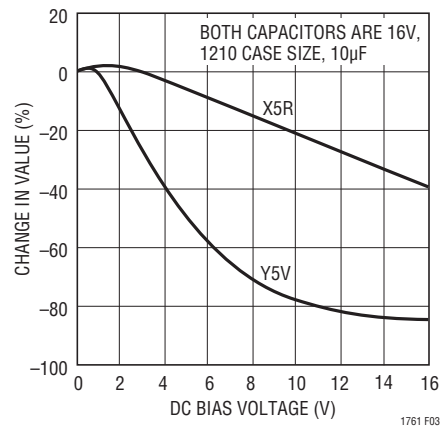

Figure 3. Ceramic Capacitor DC Bias Characteristics

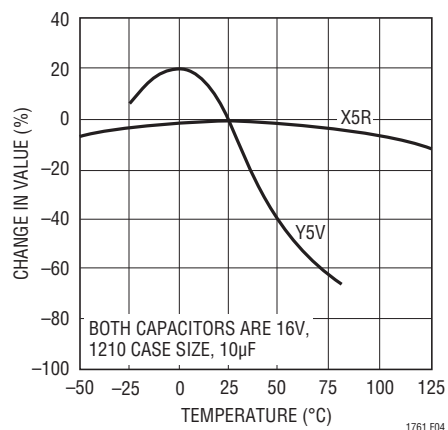

Figure 4. Ceramic Capacitor Temperature Characteristics

APPLICATIONS INFORMATION

Voltage and temperature coefficients are not the only sources of problems. Some ceramic capacitors have a piezoelectric response. A piezoelectric device generates voltage across its terminals due to mechanical stress, similar to the way a piezoelectric accelerometer or microphone works. For a ceramic capacitor the stress can be induced by vibrations in the system or thermal transients. The resulting voltages produced can cause appreciable amounts of noise, especially when a ceramic capacitor is used for noise bypassing. A ceramic capacitor produced Figure 5's trace in response to light tapping from a pencil. Similar vibration induced behavior can masquerade as increased output voltage noise.

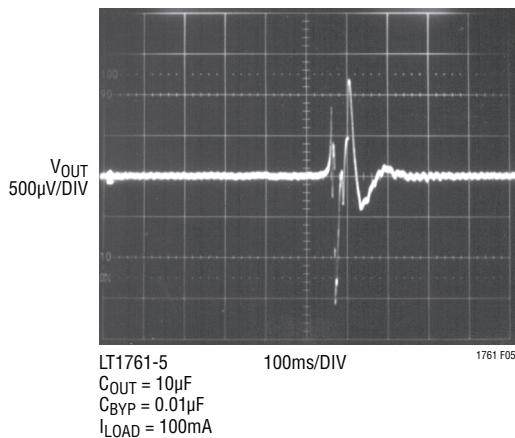

Figure 5. Noise Resulting from Tapping on a Ceramic Capacitor

Thermal Considerations

The power handling capability of the device will be limited by the maximum rated junction temperature (125°C). The power dissipated by the device will be made up of two components:

1. Output current multiplied by the input/output voltage differential: $(I_{OUT})(V_{IN} - V_{OUT})$, and
2. GND pin current multiplied by the input voltage: $(I_{GND})(V_{IN})$.

The ground pin current can be found by examining the GND Pin Current curves in the Typical Performance Characteristics section. Power dissipation will be equal to the sum of the two components listed above.

The LT1761 series regulators have internal thermal limiting designed to protect the device during overload conditions. For continuous normal conditions, the maximum junction temperature rating of 125°C must not be exceeded. It is important to give careful consideration to all sources of thermal resistance from junction to ambient. Additional heat sources mounted nearby must also be considered.

For surface mount devices, heat sinking is accomplished by using the heat spreading capabilities of the PC board and its copper traces. Copper board stiffeners and plated through-holes can also be used to spread the heat generated by power devices.

The following table lists thermal resistance for several different board sizes and copper areas. All measurements were taken in still air on 3/32" FR-4 board with one ounce copper.

Table 1. Measured Thermal Resistance

COPPER AREA		BOARD AREA	THERMAL RESISTANCE (JUNCTION-TO-AMBIENT)
TOPSIDE*	BACKSIDE		
2500mm ²	2500mm ²	2500mm ²	125°C/W
1000mm ²	2500mm ²	2500mm ²	125°C/W
225mm ²	2500mm ²	2500mm ²	130°C/W
100mm ²	2500mm ²	2500mm ²	135°C/W
50mm ²	2500mm ²	2500mm ²	150°C/W

*Device is mounted on topside.

Calculating Junction Temperature

Example: Given an output voltage of 3.3V, an input voltage range of 4V to 6V, an output current range of 0mA to 50mA

APPLICATIONS INFORMATION

and a maximum ambient temperature of 50°C, what will the maximum junction temperature be?

The power dissipated by the device will be equal to:

$$I_{OUT(MAX)}(V_{IN(MAX)} - V_{OUT}) + I_{GND}(V_{IN(MAX)})$$

where,

$$I_{OUT(MAX)} = 50\text{mA}$$

$$V_{IN(MAX)} = 6\text{V}$$

$$I_{GND} \text{ at } (I_{OUT} = 50\text{mA}, V_{IN} = 6\text{V}) = 1\text{mA}$$

So,

$$P = 50\text{mA}(6\text{V} - 3.3\text{V}) + 1\text{mA}(6\text{V}) = 0.14\text{W}$$

The thermal resistance will be in the range of 125°C/W to 150°C/W depending on the copper area. So the junction temperature rise above ambient will be approximately equal to:

$$0.14\text{W}(150^\circ\text{C/W}) = 21.2^\circ\text{C}$$

The maximum junction temperature will then be equal to the maximum junction temperature rise above ambient plus the maximum ambient temperature or:

$$T_{JMAX} = 50^\circ\text{C} + 21.2^\circ\text{C} = 71.2^\circ\text{C}$$

Protection Features

The LT1761 regulators incorporate several protection features which make them ideal for use in battery-powered circuits. In addition to the normal protection features associated with monolithic regulators, such as current limiting and thermal limiting, the devices are protected against reverse input voltages, reverse output voltages and reverse voltages from output to input.

Current limit protection and thermal overload protection are intended to protect the device against current overload conditions at the output of the device. For normal operation, the junction temperature should not exceed 125°C.

The input of the device will withstand reverse voltages of 20V. Current flow into the device will be limited to less than 1mA (typically less than 100µA) and no negative voltage will appear at the output. The device will protect both itself and the load. This provides protection against batteries which can be plugged in backward.

The output of the LT1761-X can be pulled below ground without damaging the device. If the input is left open circuit or grounded, the output can be pulled below ground by 20V. For fixed voltage versions, the output will act like a large resistor, typically 500k or higher, limiting current flow to typically less than 100µA. For adjustable versions, the output will act like an open circuit; no current will flow out of the pin. If the input is powered by a voltage source, the output will source the short-circuit current of the device and will protect itself by thermal limiting. In this case, grounding the $\overline{\text{SHDN}}$ pin will turn off the device and stop the output from sourcing the short-circuit current.

The ADJ pin of the adjustable device can be pulled above or below ground by as much as 7V without damaging the device. If the input is left open circuit or grounded, the ADJ pin will act like an open circuit when pulled below ground and like a large resistor (typically 100k) in series with a diode when pulled above ground.

APPLICATIONS INFORMATION

In situations where the ADJ pin is connected to a resistor divider that would pull the ADJ pin above its 7V clamp voltage if the output is pulled high, the ADJ pin input current must be limited to less than 5mA. For example, a resistor divider is used to provide a regulated 1.5V output from the 1.22V reference when the output is forced to 20V. The top resistor of the resistor divider must be chosen to limit the current into the ADJ pin to less than 5mA when the ADJ pin is at 7V. The 13V difference between output and ADJ pin divided by the 5mA maximum current into the ADJ pin yields a minimum top resistor value of 2.6k.

In circuits where a backup battery is required, several different input/output conditions can occur. The output

voltage may be held up while the input is either pulled to ground, pulled to some intermediate voltage or is left open circuit. Current flow back into the output will follow the curve shown in Figure 6.

When the IN pin of the LT1761-X is forced below the OUT pin or the OUT pin is pulled above the IN pin, input current will typically drop to less than 2 μ A. This can happen if the input of the device is connected to a discharged (low voltage) battery and the output is held up by either a backup battery or a second regulator circuit. The state of the $\overline{\text{SHDN}}$ pin will have no effect on the reverse output current when the output is pulled above the input.

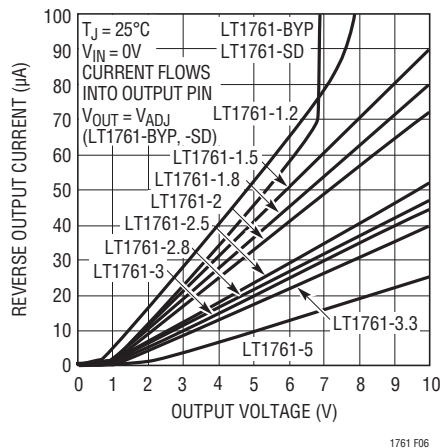
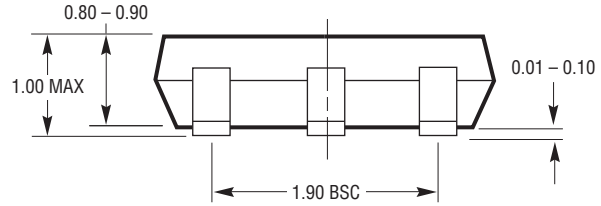
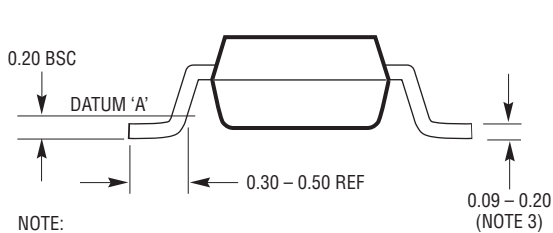
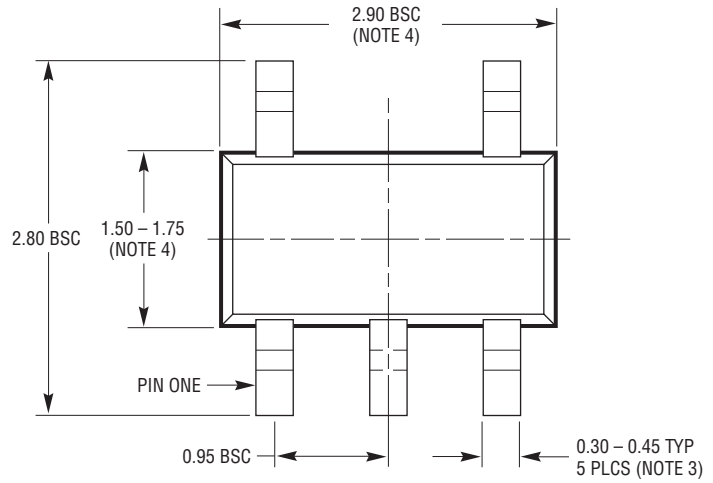
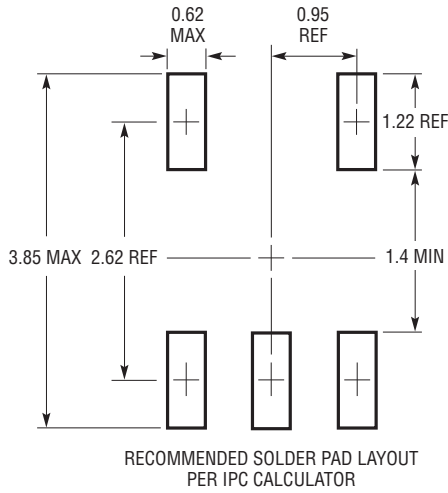

Figure 6. Reverse Output Current

PACKAGE DESCRIPTION

S5 Package
5-Lead Plastic TSOT-23
 (Reference LTC DWG # 05-08-1635)



- NOTE:
 1. DIMENSIONS ARE IN MILLIMETERS
 2. DRAWING NOT TO SCALE
 3. DIMENSIONS ARE INCLUSIVE OF PLATING
 4. DIMENSIONS ARE EXCLUSIVE OF MOLD FLASH AND METAL BURR
 5. MOLD FLASH SHALL NOT EXCEED 0.254mm
 6. JEDEC PACKAGE REFERENCE IS MO-193

S5 TSOT-23 0302 REV B

REVISION HISTORY (Revision history begins at Rev F)

REV	DATE	DESCRIPTION	PAGE NUMBER
F	5/10	Added MP-grade Added Typical Application	2, 3 22

TYPICAL APPLICATION

Noise Bypassing Provides Soft-Start

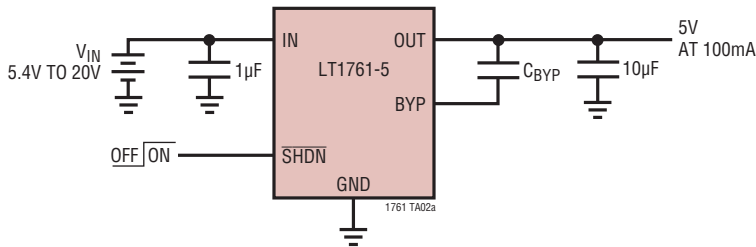

Startup Time

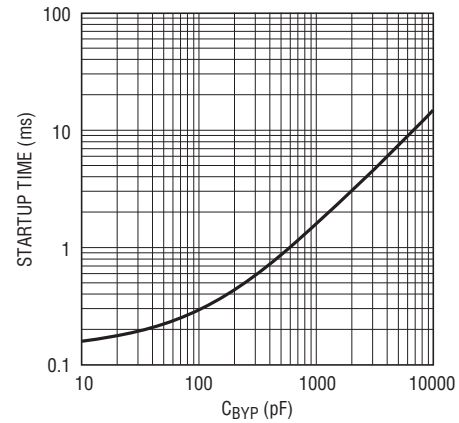

1761 TA02b

RELATED PARTS

PART NUMBER	DESCRIPTION	COMMENTS
LT1120	125mA Low Dropout Regulator with 20µA I _Q	Includes 2.5V Reference and Comparator
LT1121	150mA Micropower Low Dropout Regulator	30µA I _Q , SOT-223 Package
LT1129	700mA Micropower Low Dropout Regulator	50µA Quiescent Current
LT1175	500mA Negative Low Dropout Micropower Regulator	45µA I _Q , 0.26V Dropout Voltage, SOT-223 Package
LT1521	300mA Low Dropout Micropower Regulator with Shutdown	15µA I _Q , Reverse-Battery Protection
LT1529	3A Low Dropout Regulator with 50µA I _Q	500mV Dropout Voltage
LT1762 Series	150mA, Low Noise, LDO Micropower Regulator	25µA Quiescent Current, 20µV _{RMS} Noise
LT1763 Series	500mA, Low Noise, LDO Micropower Regulator	30µA Quiescent Current, 20µV _{RMS} Noise
LTC1928	Doubler Charge Pump with Low Noise Linear Regulator	Low Output Noise: 60µV _{RMS} (100kHz BW)
LT1962 Series	300mA, Low Noise, LDO Micropower Regulator	30µA Quiescent Current, 20µV _{RMS} Noise
LT1963	1.5A, Low Noise, Fast Transient Response LDO	40µV _{RMS} , SOT-223 Package
LT1764	3A, Low Noise, Fast Transient Response LDO	40µV _{RMS} , 340mV Dropout Voltage
LTC3404	High Efficiency Synchronous Step-Down Switching Regulator	Burst Mode [®] Operation, Monolithic, 100% Duty Cycle